

posco

ELECTRO GALVANIZED STEEL

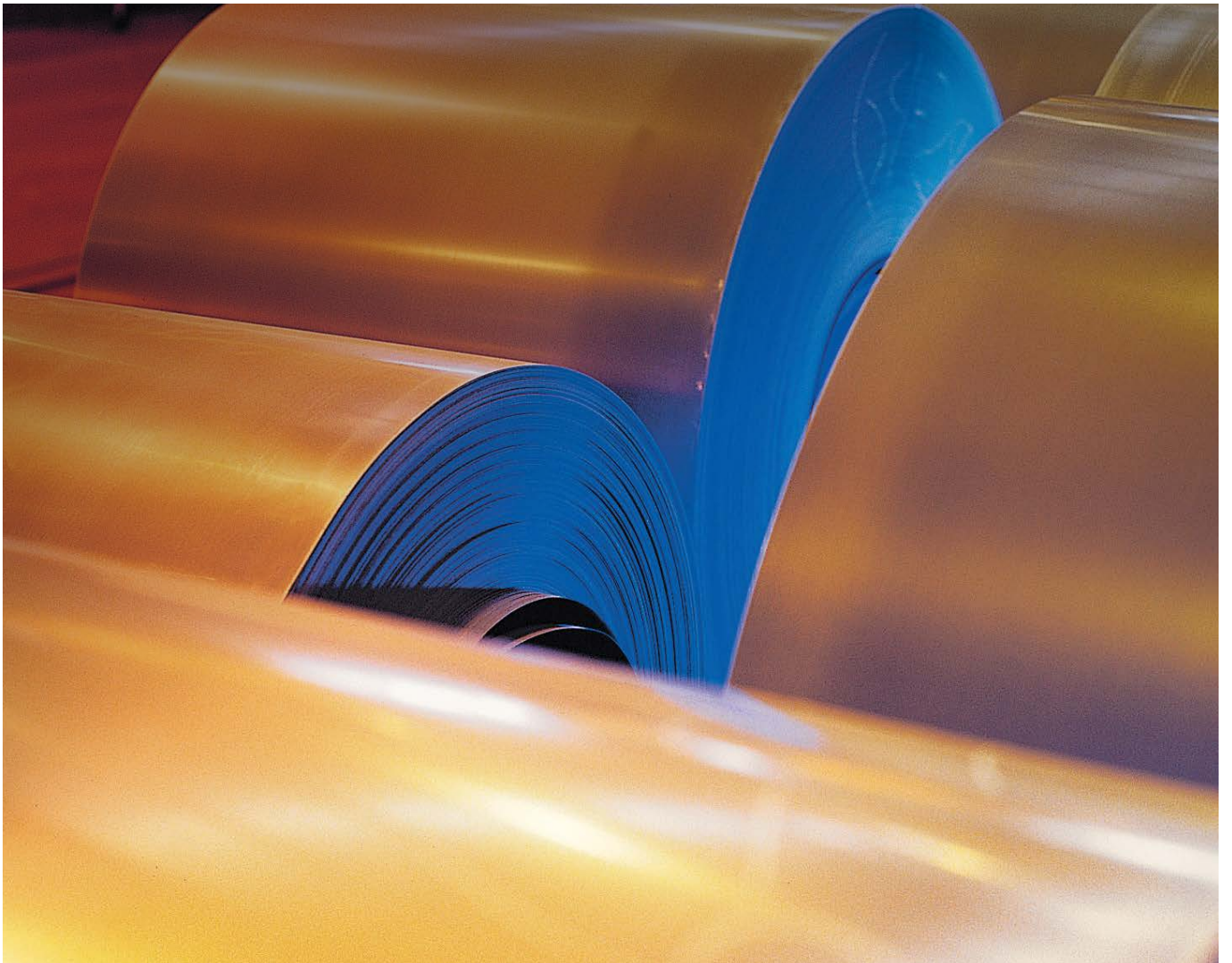

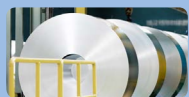

Our Electro-galvanized steels are produced with advanced processes and equipment to ensure consistent quality. We offer two types of galvanizing coating, Pure-Zn and Zn-Ni alloy and a variety of post-treatments including phosphate-based coatings, Cr-free resin, and anti-corrosion oiling. Our electro-galvanized steel products display excellent corrosion resistance as well as versatility in machinability, weldability, and paintability, making them popular materials for automobile, home appliances, building interior, metal furniture, and many other applications.

ELECTRO GALVANIZED STEEL

Contents

Pohang & Gwangyang Steelworks	04
Manufacturing Processes & Equipment	06
Manufactured Products	08
Main Uses	11
Types of Post-Treated Products	12
Characteristics of Post-Treated Products	14
Anti-Fingerprinted Steel Products	15
Steel Sheets for Automobile Fuel Tank	20
Specifications	21
Available Dimensions	23
Size Tolerances	24
Packaging & Marking	25
Ordering Information/Cautions on Use	26



Upon completion of its first-phase manufacturing facility in 1973, Pohang Steelworks, Korea's first integrated steel mill, was finally completed after 4 stages of construction at Young-il Bay in February 1981.

POSCO is capable of producing and processing a variety of carbon steels and stainless steels. The company's global competitiveness was further enhanced when we opened the world's first FINEX commercialization facility in May 2007.

Main products hot-rolled steel, plate, cold-rolled steel, wire rod, electrical steel, stainless steel, API steel, etc.

Crude steel production 16.185 million tons (as of 2013)



Gwangyang Steelworks is the world's largest integrated steel mill. It features an optimal plant layout with carbon steel processing and high-mill processing capabilities, producing automotive steel, high-strength hot rolled steel, high-quality API steel, and thick plates among other products.

With the goal of specializing in the manufacturing of the world's best automotive steels, Gwangyang Steelworks focuses on enhancing its competitive edge.

Main products hot-rolled steel, plate, cold-rolled steel, car steel, API steel, etc.

Crude steel production 20.231 million tons (as of 2013)

The POSCO Quality

Ultra-High Quality Products Which Touch the Customer's Soul

- Customer Inside: We create the best value for customers by keeping their needs foremost.
- Basic Inside: We focus on fundamentals and principles, eliminating deviation and waste.
- Synergy Inside: We seek to grow alongside our supplier chain through trust and communications.



Manufacturing Process & Equipment

In order to deliver quality products, meeting customer's requirements, POSCO is equipped with the latest fully-automated computer controlled cutting edge facilities and technologies. These tools guarantee products of the highest precision and quality for our customers.

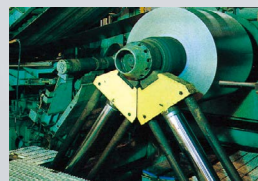
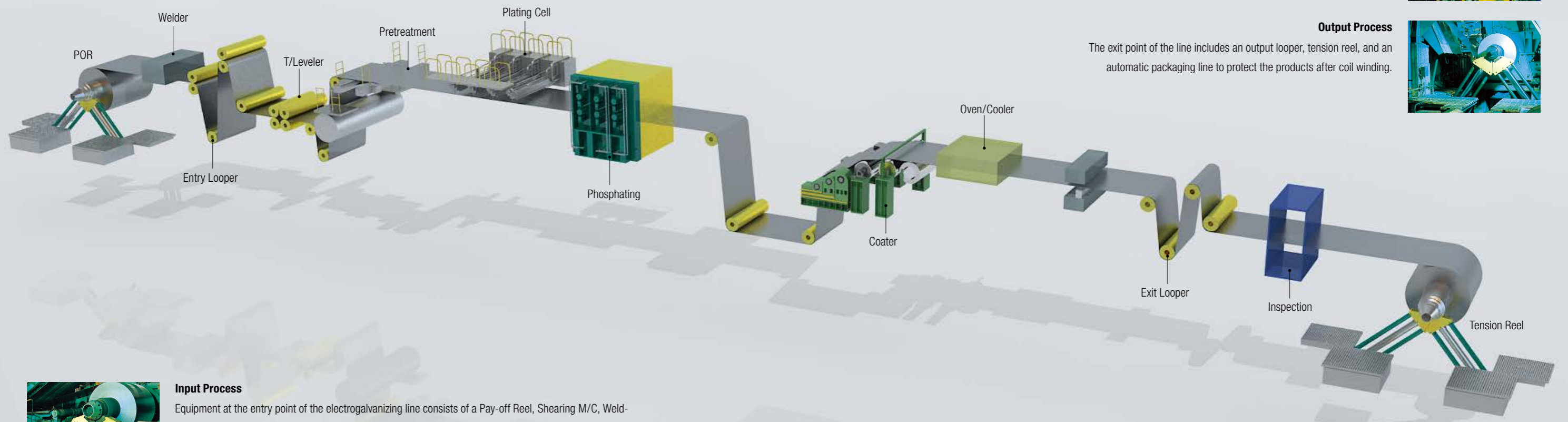

Input Process

Equipment at the entry point of the electrogalvanizing line consists of a Pay-off Reel, Shearing M/C, Welding M/C, Looper, and Tension Leveler. The pay-off reel transports stacked or cold-rolled steel materials to the shearing machine which cuts and connects them in preparation for welding. Then comes the welding machine, the looper and a tension leveler which controls the flatness of the untreated sheet steel.

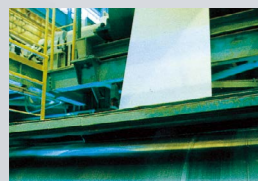

Pre-Treatment Process

An electrolytic cleaning line consists of an electrolysis tank, an acid bath and a rinse tank to remove contaminants and oxide films from the surface of the steel before electroplating.



Electric Galvanizing Equipment

POSCO produces electro-galvanized steel sheet using the LCC-H (Liquid Cushion Cell-Horizontal) galvanizing process. In this process, the steel is coated on both sides simultaneously as it passes horizontally through the line.

Phosphate Thin-Film Coating Process

A phosphate thin-film is applied to the surface of the zinc layer through chemical or electro-chemical reactions. The film is intended to provide temporary anti-corrosion protection and to generate a secure painting substrate.

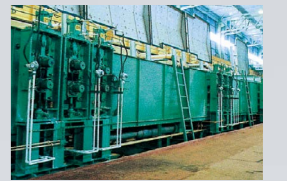

Anti-Fingerprinting Process

An organic, inorganic or organic-inorganic hybrid film is applied to the surface of sheet steel in order to supplement its corrosion resistance and to enhance desirable properties such as resistance to fingerprint marks and workability.



Output Process

The exit point of the line includes an output looper, tension reel, and an automatic packaging line to protect the products after coil winding.



Manufacturing Products

Status of Products Manufactured with Each Equipment of POSCO EGLs

Division		Gwangyang		Pohang	
Year of Completion (Streamlined)		#1 EGL	#2 EGL	#1 EGL	#2 EGL
		'90.8('11.8)	'97.8	'86.12('09.12)	'09.1
Production Capability (Thousand Tons/Year)		400	300	300	300
Size(mm)	Thickness	0.4~2.3	0.4~2.0	0.4~2.3	0.4~2.0
	Width	800~1,860	700~1,570	800~1,650	800~1,650
Zinc Plating		Zn Galvanizing	Zn Galvanizing	Zn Galvanizing Zn-Ni Alloy Plating	Zn Galvanizing
Types of Post-Treatments		No treatment, Oiling, Phosphating, Anti-fingerprinting	No treatment, Oiling, Phosphating, Anti-fingerprinting	No treatment, Oiling, Phosphating, Anti-fingerprinting, (Zn-Ni) Coating for fuel tanks	No treatment, Oiling, Phosphating, Anti-fingerprinting

Types of Galvanizing & Structures of Coated Films

Zn Plating System

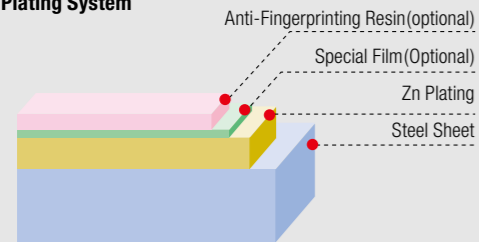

For post-treatment, various methods are offered such as no treatment, oiling, phosphating, anti-fingerprinting, black resin, etc. Electro-galvanized steels with these types of coatings are popular in the home appliance industry.

Alloy Plating System

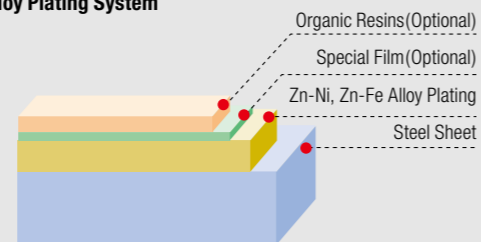

For post-treatment, various methods are offered such as oiling, phosphating, functional resin (for fuel tanks), etc. Electro-galvanized steel with these types of coating are used in the automotive industry.

Characteristics of Electro-Galvanized Steel Sheets

Zn Electro-Galvanized Steel Sheets

Workability

Since it has less coating weight and has no heat-affected zones during the manufacturing process compared with GI and GA, it secures the material characteristics and workability at the same levels of those of the base metals, that is, cold-rolled (CR) sheets.

Corrosion Resistance

Fe can be protected by the sacrificial anode reactions caused by the galvanic actions of Zinc and, in case that it is exposed to air, a thin film is formed on the surface to prevent it from being corroded. (Some post-coated steel sheets are used for automobiles in order to increase the anti-corrosion property.)

Paintability

Its flat and even surface secures the good conditions for painting and a phosphate treatment improves its paint adhesion and anticorrosion properties after painting.

Weldability

Pure Zn galvanized steel sheets weldability is a little poor since their electrical conductivity is inferior to that of cold-rolled steel sheets. But it is possible to conduct a spot or a seam welding with satisfaction along with the appropriate welding conditions and the application of some post-treatments.

Comparison of Anti-Corrosion Levels of Non-Treated and Phosphate-Treated Zn-Galvanized Steel Sheets.

White Rust Test

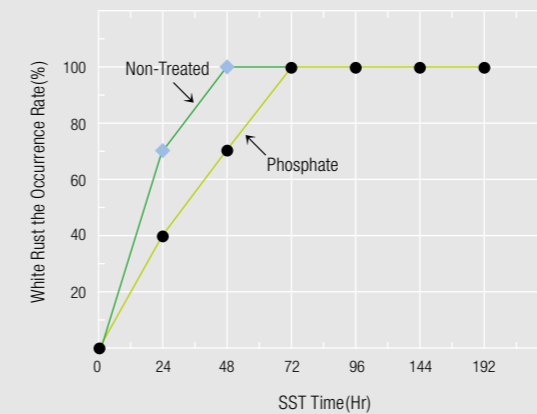

Red Rust Test

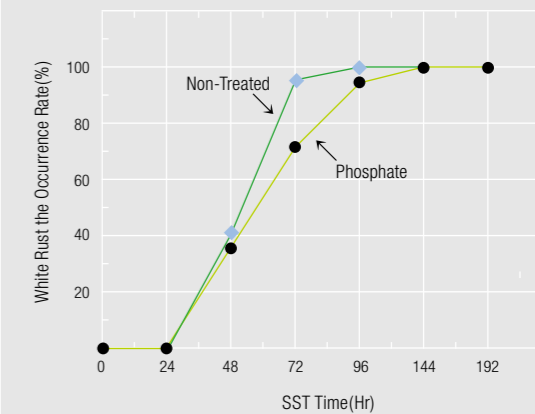

Zn-Ni Alloy Plated Steel Sheets

This product has been developed in order to improve the anti-corrosion durability (to prevent the through-hole corrosion). And also, since the coated layer of this product is solid and has a higher melting point than those of other plated layers by adding some Ni, its coated layer does not easily soften or melt unlike Pure Zn coated layer and it is also possible to conduct a low current welding compared to Pure Zn galvanized steel sheets and has a superior corrosion resistance, which prevents the steel sheets from being corroded for a long period of time.

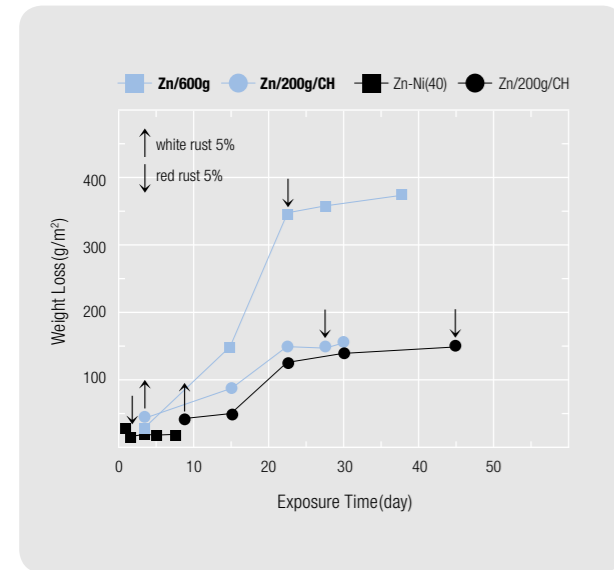

Corrosion Resistance Comparison : Pure Zn vs. Zn-Ni

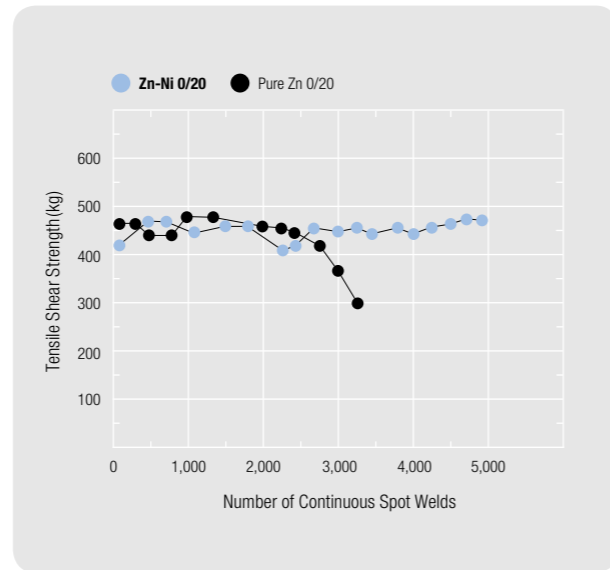

Weldability Comparison : Pure Zn vs. Zn-Ni

Pure Zn Plating

Characteristics

- Paint Adhesion(Phosphate-treated)
- Corrosion Resistance (High Corrosion Resistance: Cr-Free)
- Anti-Fingerprint Property (Anti-Fingerprint Treatment)
- Corrosion Resistance After Painting

Applications

- Inner & Outer Panels of Home Appliances
- Materials for Painted Steel Sheets
- Materials for Architectural Interior & Exterior Works & Metal Furniture

Zn-Ni Plating

Characteristics

- Anti-Corrosion property
- Welding Property
- Paint Adhesion

Applications

- Inner & Outer Panels of Automobiles
- Door Outer
- Hood
- Fender
- Rear Floor

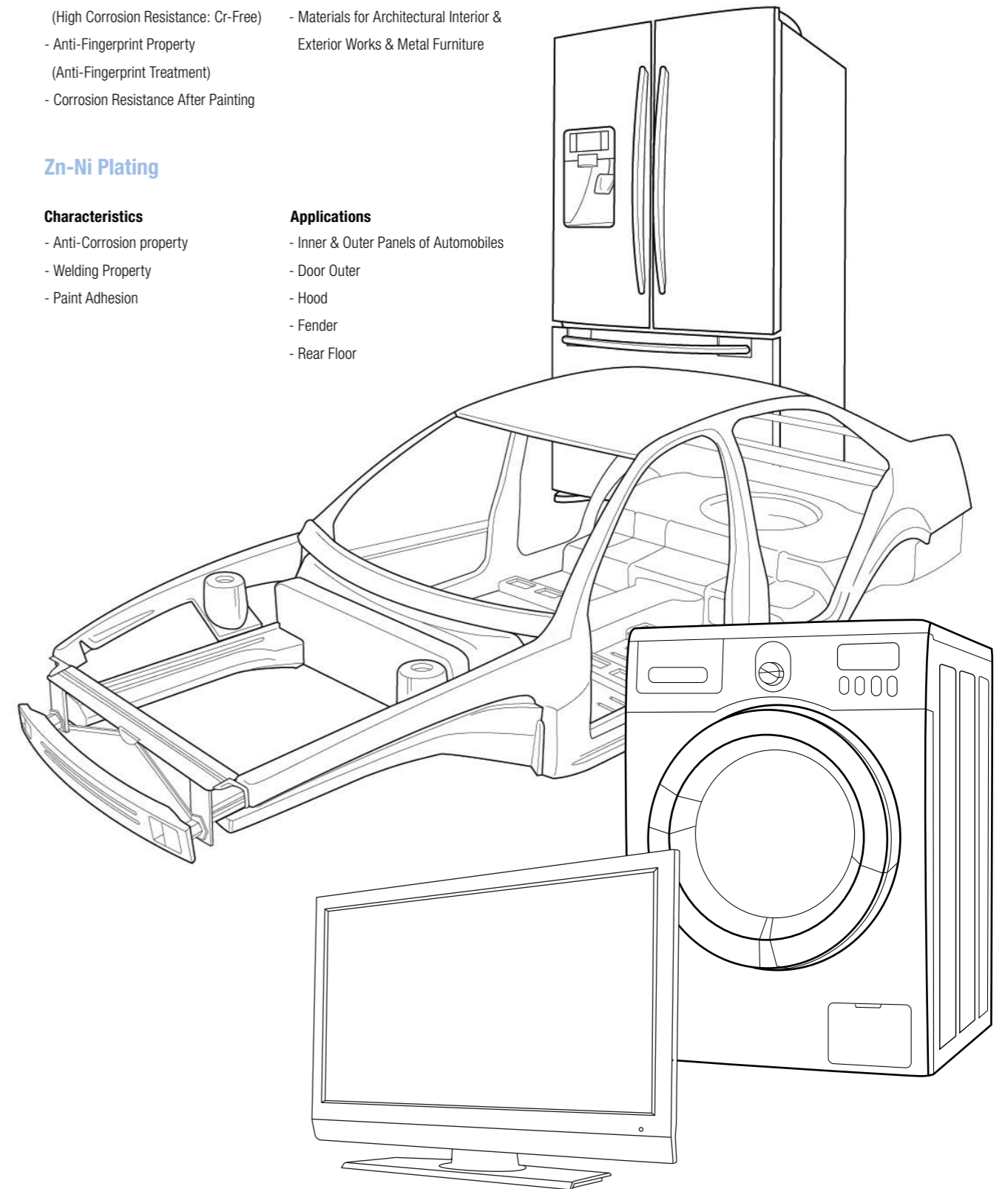

Types of Surface-treated Products

Structure of Coated Film

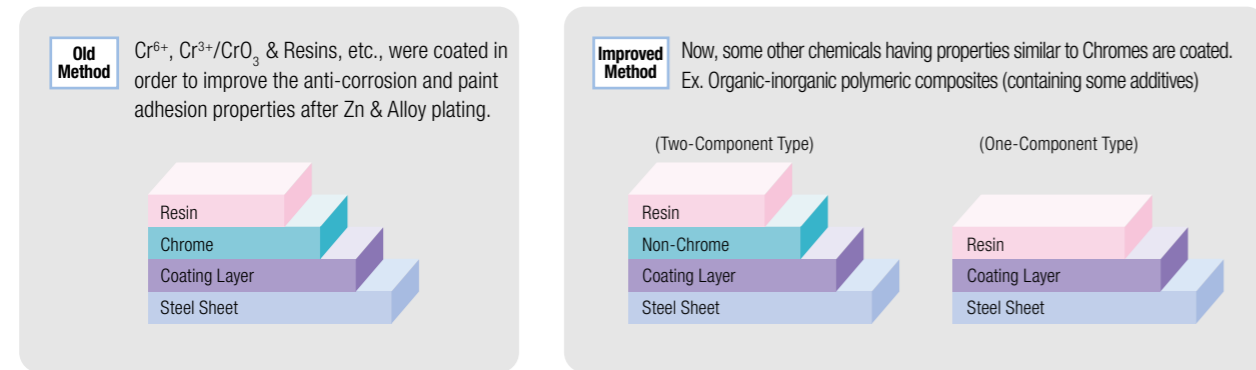

* Cr⁶⁺ (Hexavalent Chrome): It has superior economic efficiency and anti-corrosion property, but is a pollutant fatally damaging a human body that is subject to some environmental regulations.

Post-Treatment Code

Division	Post-Treatment Codes	Full Name	Quality Characteristics
Non-Treated	XX	-	-
Phosphate	PL	Phosphate Light	Paintability
	PM	Phosphate Metallic	Paintability, Corrosion Resistance, Workability
Anti-Finger Printed	AG	Antifinger General	Anti-Fingerprinting Property, Corrosion Resistance, Conductivity
	AL	Antifinger Lubricant	Anti-Fingerprinting Property, Corrosion Resistance, Resistance to blackening-after-processing
	AC	Antifinger Conductivity	Anti-Fingerprinting Property, Corrosion Resistance, Conductivity
	AF	Antifinger Formability	Anti-Fingerprinting Property, Corrosion Resistance, Workability
black resin	BT, BL	-	-
For Fuel Tanks	GX	-	Solvent Resistance, Workability, Paintability

Status of Post-treated Products

Division	Post-Treatment Code	Structure of Coated Layers	Characteristics	Main Usage	Manufacturing Facility Location
Pure-Zn	EG non-treated steel	XX 	Corrosion Resistance, Smooth surface	Color steel sheets, Home appliances/Components of Furniture	Pohang & Gwangyang
	Phosphate-treated steel	PL, PM 	Coating adhesion	For painting for separate parts, Home appliances	Pohang & Gwangyang
	AG/AL (Anti-finger General/Lubrication)		Corrosion Resistance, Anti-Fingerprinting Property	For LCD, For copiers, For computer parts	Pohang
	Fingerprint resistant steel	AF (Anti-finger Formability) 	Workability formability	For electronic appliances (for deep processing)	Gwangyang
	AC (Anti-finger Conductivity)		Conductivity	For OA	Gwangyang
Black resin-treated steel		BT, BL 	Corrosion Resistance, Coating adhesion, Color	For exterior surfaces of home appliances	Pohang
Zn-Ni	Non-treated	XX 	Raw corrosion resistance, Weldability, Paintability	For interior and exterior surfaces of automobiles and automotive parts	Pohang
	Fuel tanks	GX 	Gasoline resistance, Weldability, Corrosion Resistance	For automotive fuel tanks, Radiator Support	Pohang

Characteristics of Post-Treated Products

Characteristics of Post-treated Products

Non-Treated

Since some white rust can be formed on the surface of this product without any post-treatments after plating, it should be used right after being delivered.

Oil-Coated

For the purpose of protecting the surface temporarily until the client uses the product, oil is coated on the surface, so it has a strong white rust resistance. Since non-treated steel sheets are easily affected by white rust in general, small amount of oil is coated on the surface of most of steel sheets. However, if a client wants to conduct a sophisticated painting work on the surface of such steel sheets, the surface should be cleaned by skimming off all the oil.

Phosphate-Coated

This coating method is applied to some steel sheets, which are used by clients in order for them to use them after painting without any pretreatments, so, such steel sheets are used for manufacturing some components of industrial electronic appliances, such as air-conditioners, refrigerators & distribution panel cases, etc. It has a superior paintability, but its anti-corrosion property is inferior to that of resin-coated steel sheets like anti-fingerprinted products.

Anti-Fingerprinted

It is a surface treatment method to be done for the purpose of preventing any inferiority like pollution by fingerprints or stains left on the surface of galvanized steel sheets while being dealt with or processed. Due to some organic-inorganic coating treatments, it has some superior properties, such as high corrosion resistance, vivid surface color and high workability, etc.

Products for Fuel Tanks of Automobiles

For a preparation of environmental regulations on Pb-coated products, some eco-friendly, Pb- or Cr-free steel sheets are being developed by replacing the old Pb- or Cr-coated products. Such steel sheets have some superior properties, such as high corrosion resistance and superior workability.

Anti-Fingerprinted Steel Sheets

Types and Quality Characteristics of Anti-Fingerprinted Steel Sheets

◎ Very Good ○ Good △ Ordinary

Division	Post-Treatment Code	Quality Characteristics					
		Corrosion Resistance	Anti-Fingerprinting Property Solvent Resistance	Workability	Weldability	Conductivity	Paintability Printability
Anti-Finger Printing Property	AG	◎	◎	○	○	○	○
	AL	◎	◎	◎	○	○	○
	AC	○	◎	○	◎	◎	△
	AF	◎	◎	◎	△	-	○

Note) However, it can be differences in quality characteristics depending on the conditions used.

Application of Anti-Fingerprinted Steel Sheets



Anti-Fingerprinted Steel Sheets

Characteristics of Post-Treated Products

Division	Detailed Assessment Methods	Assessment Criteria*	Assessment Tools
Resin Coating Weight(mg/m²)	Resin Volume Analysis After some plated layers are resolved by some hydrochloric acid	-	ICP, AA, XRF
Anti-Fingerprinting Property(ΔE)	Color Differences before and after coating the white base line	ΔE ≤ 0.5	A Spectrum Color Sensor
Chemical Resistance (ΔE)	Solvency Color Differences before / after rubbing with acetone (A special solution can be used by an order of a client, if necessary)	ΔE ≤ 2.0	A Spectrum Color Sensor
	Alkali Concentration in cleaning solution 5%, 5minutes, 45°C, stirring), Color difference before / after treatments	ΔE ≤ 2.0	A Spectrum Color Sensor
Blackness Resistance(ΔE)	RH 85%, 60°C, 110hrs whiteness before and after a passage of time	ΔL* ≤ 1.5	Hot Humidifier
Corrosion Resistance	Flat side & Ericshen processed point Initial white rusting point	Temporary Rust Resist : ≥24hr Anti-Fingerprint Resist : ≥72-96hr High Corrosion : ≥96-120hr	Salt spray Test
Coat/Print Adhesiveness	Coating/Baking(150°C, 20minutes, 20-25μm) 100wood logs(1mm gap)	Remaining Coating 100/100	Cross-Cutter
Workability (Friction, Blackening)	•Drawing Speed : 1,000mm/min •Bead Radius : R 4.75	Friction Coefficient ≤0.20 Treated Zone : ΔE ≤ 1.5	D. Bead Tester
Conductivity	Surface Resistivity Measurements using	0.2mΩ under	LORESTA-EP, GP
Weldability	•Pressure : 250kgf •Weld Time : 16cycle •Electrode : Cu-Cr(RWMA Class II)	Appropriate Welding Current Range : 5.0-9.0KA	Spot Welder

* The items of basic assessment criteria as general standards of our company can be changed on a client's demand.

■ Corrosion Resistance

■ Parts of Flat Sheet Metal

48hr

72hr

■ Parts of Processed Sheet Metal

48hr

72hr

•Test Solution: De-Ionized Water, Concentration of Solution : NaCl 5±0.5%, Specific Gravity of Solution : 1.0259~1.0329 (at 35°C)
•Test Methods Corrosion Resistance : Specimen Holder, Angle: 20°, Air Saturator Temperature: 47°C

■ Chemical Resistance

*Checking the color difference between the surfaces after conducting a salt spray test (SST) for 48 hours following a chemical solution treatment

■ Perspiration Resistance

- Artificial Perspiration (ph : 4.5)
- NaH₂PO₄ 12H₂O 8g+NaCl 8g+Acetic acid 5g

■ Alkaline Oil Skimming

- Solution: Concentration of Skim Off Solution: 5%
- Treatment Conditions : 45°C 5min Spray







■ Solvent Resistance*

*As a special analysis item, checking the color difference between the surfaces after conducting a salt spray test (SST) following a rubbing process with the relevant solvent

■ Benzene



■ White Gasoline



■ Non-Washed Oil

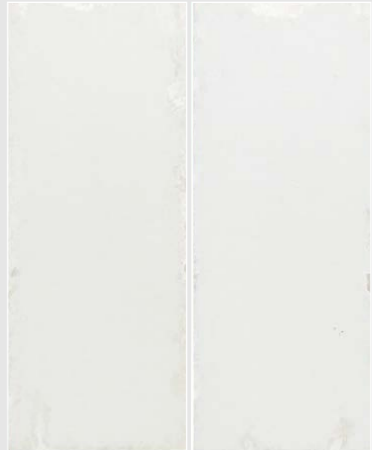

Anti-Fingerprinted Steel Sheets

Paintability / Printability

Evaluation of Paintability

- Type of Paint : Melamine-Alkyd
- Painting Method : liquid spray painting
(Baking Temperature : 175°C×20min, Membrane : 20μm)

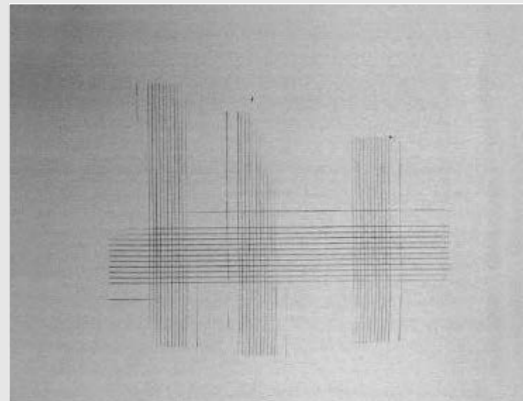

Evaluation of Printability

- Type of Paint : Seiko1300EX, 1400CEX ink
- Painting Method : Silk Screen Printing
- Adhesion Assessment (/Test) Method:
After a salt spray test (SST), a tape peel-off test



Workability

Friction Coefficient Measurement

- Friction Testers
- Frictions Tester Requirements
Load : 600kgf(0.5kgf/mm²)
Speed : 1,000m/min
Distance : 100mm



Blackening Resistance property on Frictional Surface

- Testing the Surface Color Differences after a Draw Bead Test
- Color Differences between the Surfaces processed according to the quality control standards: $\Delta E \leq 1.5$

Old Cr-Coated Products (Friction Coefficient: 0.3) Cr-Free (Friction Coefficient: 0.08)



Conductivity

LORESTA-GP, EP

- Average Value of Measurements at 9 companies (offices, stores) using the products



Weldability

Assessment Method for Welding Current Range

- Fracture Shapes and Existence of Splashes on the Welded Part after a Tensile Test

Assessment Method for Electrode Lifespan

- Maximum Number of Weld Points (Nugget Diameter: more than 5√t) with which the base metal was not fractured after conducting a tensile test by a 100 welding points gap up to 2,000 welding points.



<AC Spot Welder : 75kVA>

Electrodes	Welding Conditions
Cu-Cr (RWMA Class II)	<ul style="list-style-type: none"> - Current : 6~12.5kA - Pressure : 250kgf - Weld Time : 16 cycle

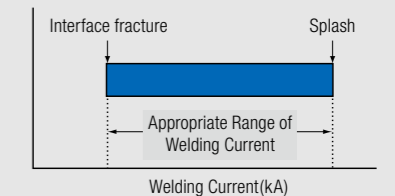

Results of Weldability Test

Division	General Cr-Free Products	High-Speed Welded Cr-Free Products
Welding Current	5.0~9.0kA	6.5~11.5kA
Number of Weld Points	800~1,500	Over 1,500 Weld Points

■ Main Usage

Environmental restrictions on Pb compounds preclude the use of traditional Pb-Sn plating methods for automotive fuel tanks. This eco-friendly Cr-free product was developed as a replacement of Pb, Pb-Sn Plating Product.

■ Structure of Galvanized Layers

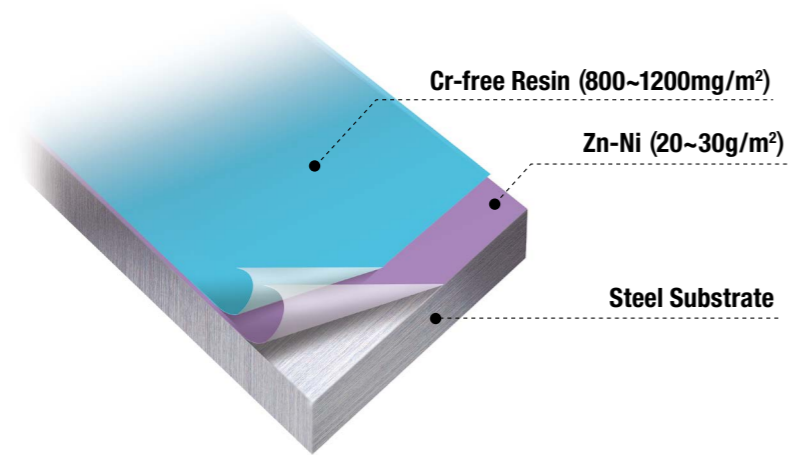

■ Quality Characteristics

Division	Gasoline Corrosiveness	Paintability	Workability (Friction Coefficient)	Weldability		Corrosion Resistance SST(600h)
				Spot	Seam	
Improvement(Cr-free)	○	○	0.121	5.2~8.2kA	12~16kA	Red Rust < 1%
Previous(Pb-Sn)	○	△	0.133	6~8kA	13~16kA	Red Rust < 1%

Available Sizes & Mechanical Properties

Division	POSCO		Bend Test	
	Pure-Zn	Zn-Ni	Bend Angle	Radius of Flexure
Class 1	EGSC	ENSC	180°	Completely Contact
Class 2	EGSD	ENSD		
Class 3	EGSP	ENSP		
	EGSN	ENSN		
Structural Quality*	EGSE	ENSE		2.0 Times the Sheet Thickness
	EG37	EN37		2.0 Times the Sheet Thickness
High Tensile Steel*	EGCHSP60TR	ENCHSP60TR	Completely Contact	
	EGCHSP35R	ENCHSP35R		
	EGCHSP40R	ENCHSP40R		
	EGCHSP35E	ENCHSP35E		
	EGCHSP38E	-		

Note) *Marked Dimensions should be determined after an advance consultation with us.

POSCO			Corresponding Dimensions		
Mechanical Properties			Notes	JIS/KS	ASTM
YP(Mpa)	TS(Mpa)	EL(%)			
-	≥270	≥37	Shallow Drawing Quality	SECC	A591-CQ
-	≥270	≥28	Drawing Quality	SECD	A591-DQ
-	≥270	≥40	Deep Drawing Quality	-	-
-	≥270	≥40	Non-aging Deep Drawing Quality	SECE(N)	A591-DQSK
-	≥270	≥46	Non-aging Extra-Deep Drawing Quality	-	-
(≥270)	≥360	≥20	Structural Quality(37kg Grade)	-	-
≥350	≥590	≥17	Commercial Quality(60kg Grade)	-	-
≥180	≥340	≥34	Drawing Quality(35kg Grade)	-	-
≥220	≥390	≥31	Drawing Quality(40kg Grade)	-	-
≥160	≥340	≥34	Deep Drawing Quality(35kg Grade)	-	-
≥200	≥370	≥33	Deep Drawing Quality(38kg Grade)	-	-

Note) 1. It is necessary to consult with us for the value in the ().
2. Please consult with us additionally, if you want some high tensile steel sheets in the corresponding dimensions.

POSCO Specifications

KS & JIS Standards

Two types of zinc coating weights, that is, the same weight on both sides and differentiated weights on each side, are applied to the steel sheets and steel coils. The standard and minimum Zn coating weights are marked with a code combining the coating weight of each side while dividing two weights with a slash (/). The marking methods are as follows.

For Steel Sheets

Minimum coating weights on the "top/bottom" sides (e.g.: E16/E16)

For Steel Coils

Minimum coating weights on the "outer/inner" surfaces of coil (e.g.: E8/E16)

When attaching a label indicating an application of "differentiated coating weights" on two sides of the steel sheets or coils, a letter "D" is written after the minimum coating weight code on the surface with the label. (e.g.: 30/10D)

Zn Coating Weight Marking Codes	Minimum Zn Coating Weight (One Side)		Standard Coating Weight	Corresponding Zinc Thickness(mm) / One Side
	Both-Sided Coating	Single Side, Differential Galvanizing		
EB	2.5	-	3	0
E8	8.5	8.0	10	0.001
E16	17.0	16.0	20	0.003
E24	25.5	24.0	30	0.004
E32	34.0	32.0	40	0.005
E40	42.5	40.0	50	0.006

Note 1. Coating Weight Marking Codes exceeding 1.40g/m² and Minimum Coating Weight are determined with an agreement between an orderer and a manufacturer.
2. The thickness codes of Electro-galvanized steel sheets are written down to the first place below decimal point by using the Zn Content level, 7.1g/cm², referring to KSA 0021 (the Rounding-off Method).

ASTM Standards

Division	Minimum Value (3) Points		Minimum Value (1) Points	
	Coating Weight Both Side		Coating Weight Both Side	
	oz/ft ²	g/m ²	oz/ft ²	g/m ²
A	-	-	-	-
B	0.08	24	0.07	22
C	0.16	48	0.15	0.003

Available Dimensions

Pohang

Thickness(mm) Width	0.1	0.2	0.3	0.4	0.5	0.6	0.7	0.8	0.9	1.0	1.1	1.2	1.3	1.4	1.5	1.6	1.7	1.8	1.9	2.0	
700																					
750																					
800																					
850																					
900																					
950																					
1000																					
1050																					
1100																					
1150																					
1200																					
1250																					
1300																					
1350																					
1400																					
1450																					
1500																					
1550																					
1600																					
1650																					
1700																					

Kwangyang

Thickness(mm) Width	0.1	0.2	0.3	0.4	0.5	0.6	0.7	0.8	0.9	1.0	1.1	1.2	1.3	1.4	1.5	1.6	1.7	1.8	1.9	2.0	
700																					
750																					
800																					
850																					
900																					
950																					
1000																					
1050																					
1100																					
1150																					
1200																					
1250																					
1300																					
1350																					
1400																					
1450																					
1500																					
1550																					
1600																					
1650																					
1700																					

Size Tolerances

⚠ The size tolerances are based on the standards of KS and JIS.
When you demand some different sizes from those specified below, it is necessary to consult with us in addition.

Thickness Tolerances

(Unit : mm)

Thickness \ Width	Thickness Tolerances				
	less than 630	over 630 up to 1,000	over 1,000 up to 1,250	over 1,250 up to 1,600	over 1,600
over 0.25 below 0.40	±0.04	±0.04	±0.04	-	-
over 0.40 below 0.60	±0.05	±0.05	±0.05	±0.06	-
over 0.60 below 0.85	±0.06	±0.06	±0.06	±0.06	±0.07
over 0.85 below 1.00	±0.06	±0.06	±0.07	±0.08	±0.09
over 1.00 below 1.25	±0.07	±0.07	±0.08	±0.09	±0.11
over 1.25 below 1.60	±0.08	±0.09	±0.10	±0.11	±0.13
over 1.60 below 2.00	±0.10	±0.11	±0.12	±0.13	±0.15
over 2.00 below 2.30	±0.12	±0.13	±0.14	±0.15	±0.17

- Note) 1. Thickness tolerance is applied by adding the Zn thickness to the ordered thickness.
2. A measuring point can be placed anywhere within 15mm inside the edge.
3. In case of using some cold-rolled base metal sheets.

Width Tolerance (of mill edges)

(Unit : mm)

Width	Base Metal Sheets	Cold Rolled Sheets
	less than 1,250	
1,250 over		10 0

Length Tolerance

(Unit : mm)

Length	Base Metal Sheets	Cold Rolled Sheets
	less than 2,000	
over 2,000 less than 4,000		+15 0
over 4,000 less than 6,000		+20 0

Maximum Flatness Tolerance

(Unit : mm)

Width	Deformation	Wave	Edge Wave	Center Wave
		less than 1,000	12	8
over 1,000 less than 1,250	15	9	8	
over 1,250 less than 1,600	15	11	8	
over 1,600	20	13	9	

(In case of using some cold-rolled base metal sheets)

Maximum Straightness Tolerance

(Unit : mm)

Width	Length	Sheet		Coil
		less than 2,000	over 2,000	
less than 630		4	4 in an arbitrary length of 2,000	
over 630		2	2 in an arbitrary length of 2,000	

(In case of using some cold-rolled base metal sheets)

Packing



Name of outer pack

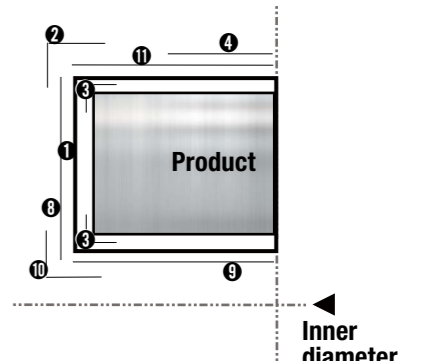

Name of cross-sectional pack

Inner diameter

NO	Name	Material
①	PP VCI WRAP	VINYL
②	OUTER RING	STEEL
③	CORNER WRAP	ANTI-RUST BOARD
④	OUTER PROTECT BOARD	STEEL
⑤	HORIZONTAL BAND	STEEL
⑥	CENTER BAND	PET
⑦	VERTICAL BAND	STEEL
⑧	SIDE BOARD	PLASTIC
⑨	INNER PROTECT BOARD	PLASTIC
⑩	INNER RING	STEEL
⑪	OUTER PROTECT BOARD	ANTI-RUST BOARD

* Packing Type and materials are changeable.

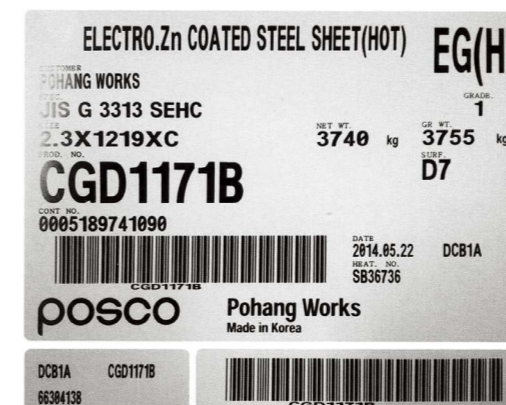

Ordering Information / Cautions on Use

When you place an order, please check the following matters according to the main uses of the products.

Product Name & Dimensions Please select the appropriate product name and dimensions depending on the main purposes of the relevant product referring to this catalog.

Usage, Post-Treatment It is very important to designate some appropriate post-treatment methods depending on the quality emphasized and the environments to use since we control the quality appropriately to each purpose of use.

Coating Weight Please select a coating weight appropriate according to the required corrosion resistance level, conditions to use and the processing method. In case of highlighting its corrosion resistance property, please select post-treated plating method and in case of emphasizing workability, select a foil plating method.

Oiling Please select either method of an oiling with anti-rust oil or no-oiling. Please select an oiling method in order to improve an interim anti-rust property and reduce any fingerprinting contamination or damages while in use. Since some white rust can be formed on the surface of a product without oiling, please handle them carefully while keeping in mind of the Cautions given below.

Dimensions The available dimensions to be manufactured are based on the standard thickness, width and length specified by the KS, JIS and ASTM Standards and the other dimensions are available by a tolerance of 0.05mm for thickness and 1mm for width and length on demand.

EDGE Please designate either a mill or slit edge type according to the conditions to use. Especially, for a product with which a stern controlling of the width is required, it is recommended to select a slit edge type.

Packaging Weight Please select the maximum net weight for steel coils (if necessary, minimum net weight) according to your unloading capability or work conditions.

- Sheet Metal: Over 3 tons incl.

- Sheet Coils: A tonnage between 5 and 30 tons

In other cases, it is required to consult with us.

In addition, the average net weights of the products, which are actually delivered, are determined based on the relationship between the maximum net weight and the dimensions.

Inner & Outer Diameters In case of steel coils, please designate the exact inner & outer diameters according to the specifications of an un-coiler equipped into your shear line system.

Inclusion of Pickled Weld Seam In some cases of cold-rolled galvanized steel sheets, a weld seam or zone is sometimes included during the pickling process. If it is difficult depending on the usage, please designate non-inclusion of any pickled weld seam or zone in advance. But, in this case, the size of steel coil is limited.

Dimensional Tolerance(Thickness, Width and Length) However, there are some cases that some specifications should be strictly met according to the conditions to use, such as precision in assembly and of components, etc. In case of such a demand, please check the specifications in advance by consulting with us.

Electro-galvanized steel cannot deliver the robust quality and performance expected unless handled in the proper manner. Please take care to heed the following guidelines during use.

Surface management Please be cautious not to damage or mar the surface during transit or manufacturing.

Processing Please take sufficient care of the processing environment. Refrain from processing steel at high temperature or in areas with high concentrations of toxic or corrosive fumes.

Storage Please store steel in a dry place. Do not store the steel where it may be exposed to moisture or where temperature changes are large. Please avoid outdoor storage as this accelerates rust formation.



Inventory Period To the extent possible, please minimize the duration of storage of your stock.

ELECTRO GALVANIZED STEEL

Copyright © 2014 by POSCO
All rights reserved

Contact Us

POSCO Center 440, Teheran-ro,
Gangnam-gu, Seoul, Korea
Global Technical Center
TEL 82-2-3457-1818/3948



Headquarters

6261, Donghaean-ro, Nam-gu, Pohang-si,
Gyeongsangbuk-do 790-300, Korea

TEL 82-54-220-0114

FAX 82-54-220-6000

Seoul Office

POSCO Center, 440, Teheran-ro,
Gangnam-gu, Seoul 135-777, Korea

TEL 82-2-3457-0114

FAX 82-2-3457-6000

Pohang Works

6261, Donghaean-ro, Nam-gu, Pohang-si,
Gyeongsangbuk-do 790-785, Korea

TEL 82-54-220-0114

FAX 82-54-220-6000

Gwangyang Works

20-26, Pokposarang-gil, Gwangyang-si,
Jeollanam-do 545-711, Korea

TEL 82-61-790-0114

FAX 82-61-790-7000



www.posco.com

www.steel-n.com